

Art. Nr. 2846496

1/6

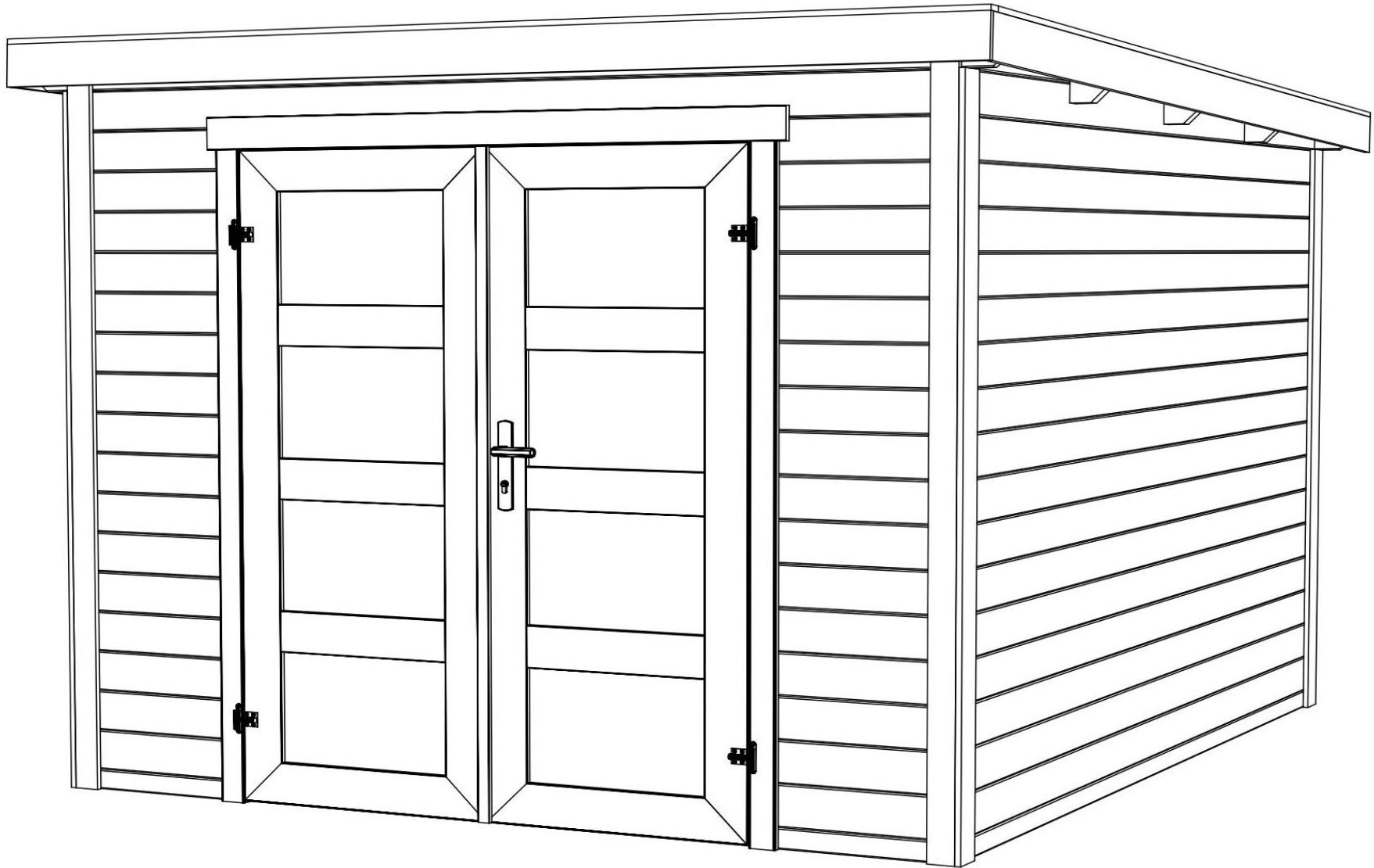

12.02.2020

Groundplan - Grundplan - Plan de masse -
Planimetria - Plattegrond - Põhiplaan

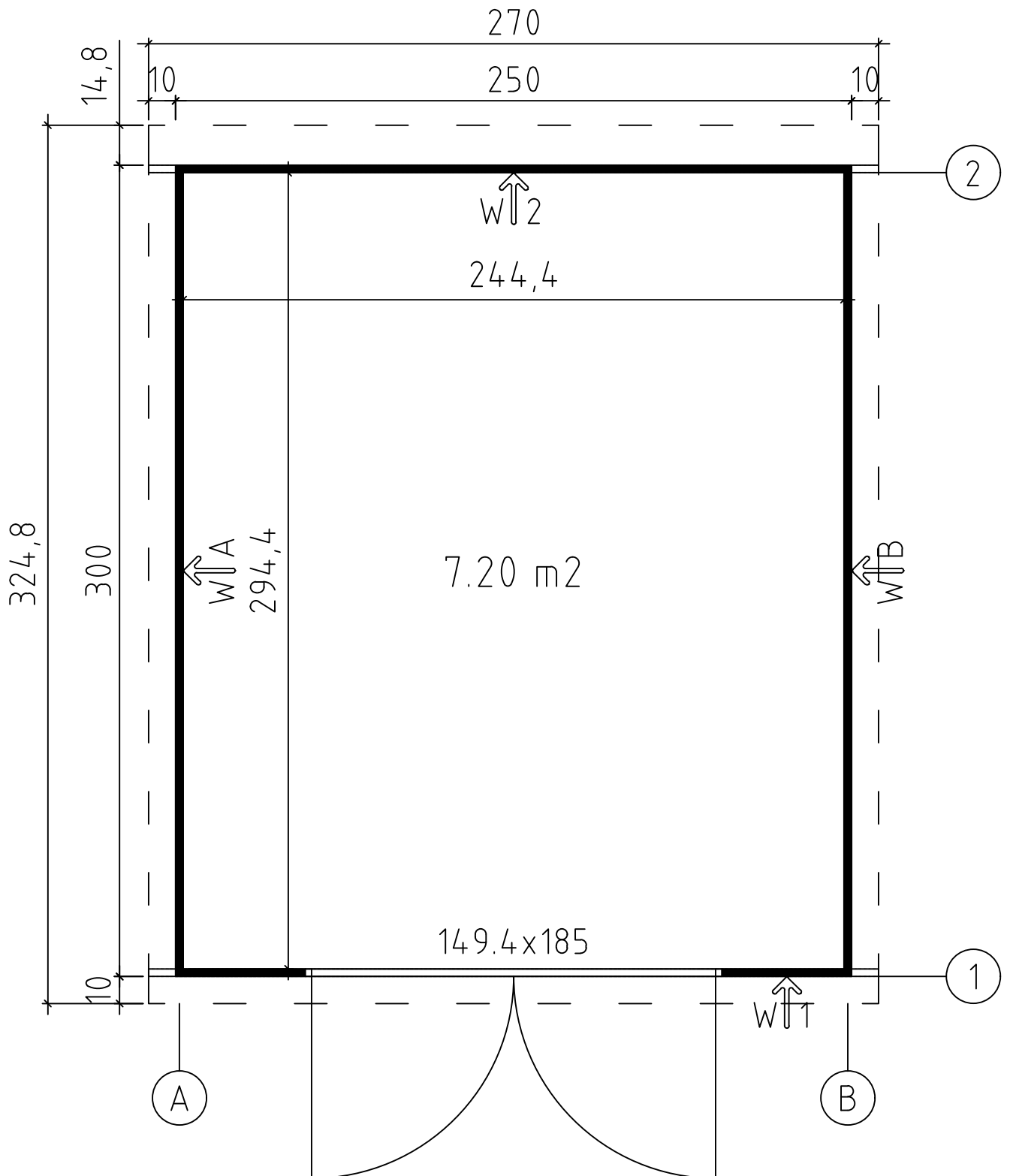



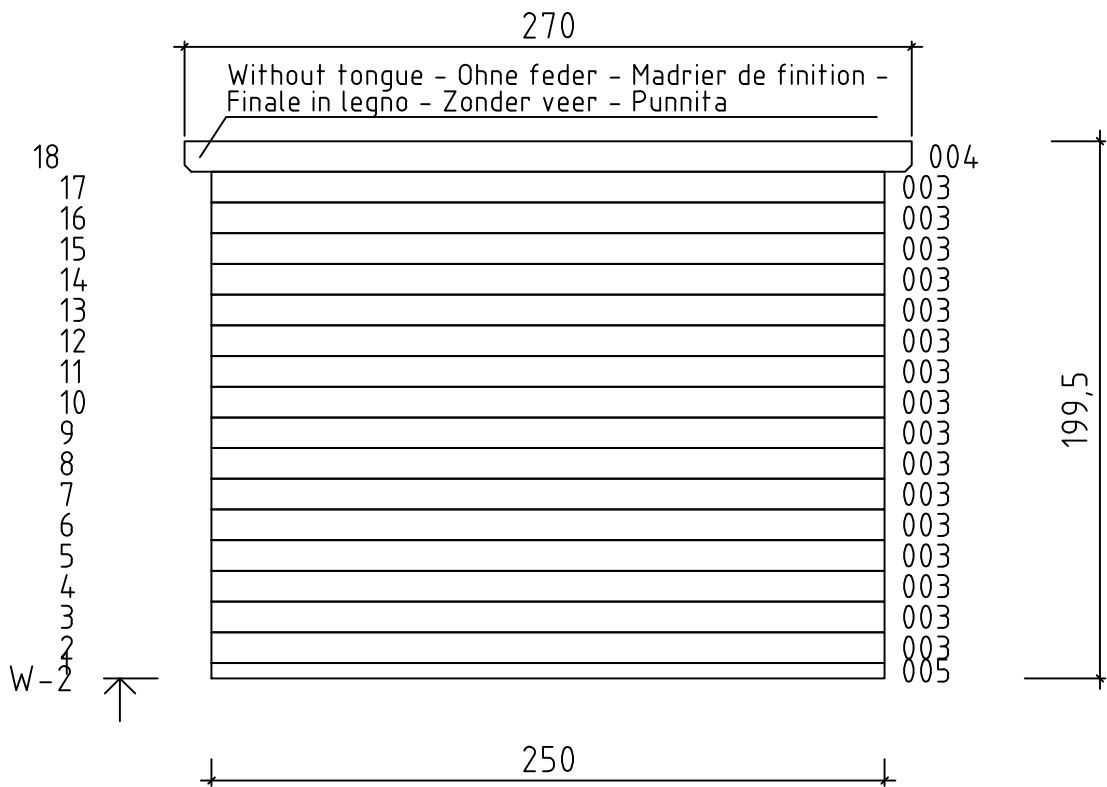
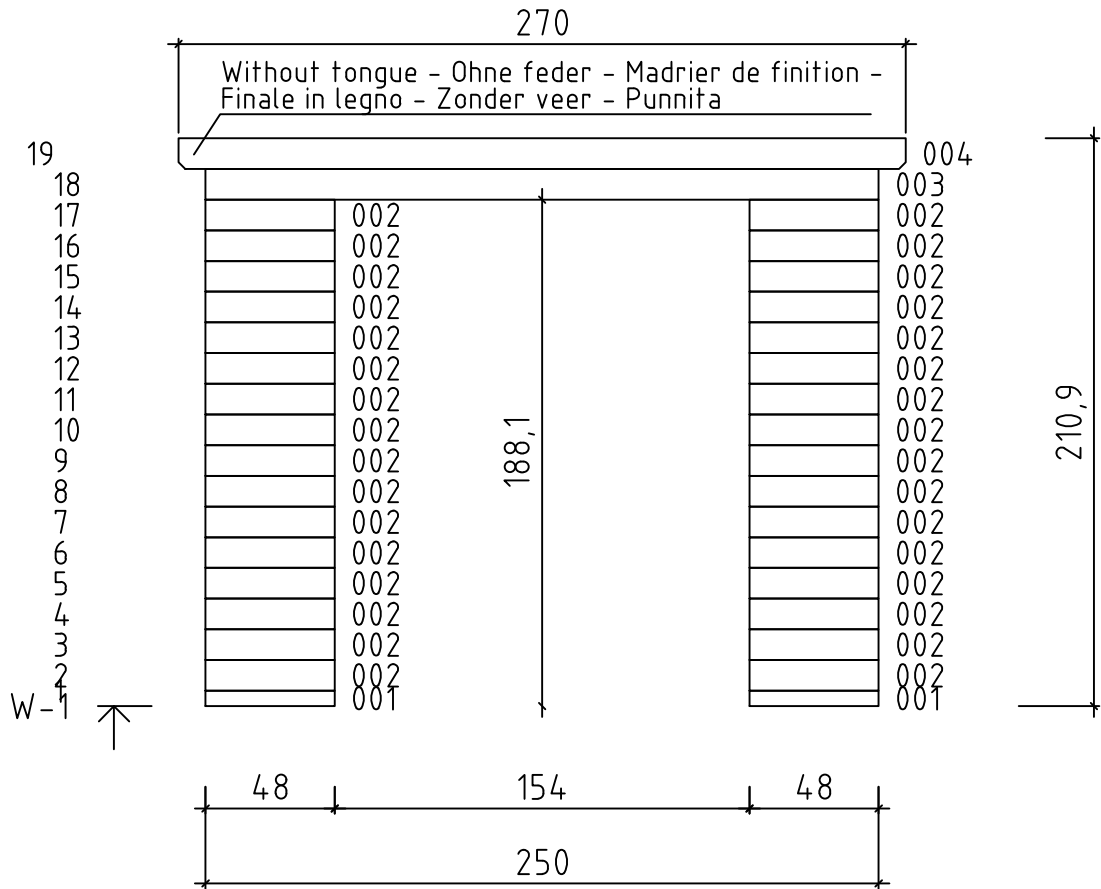



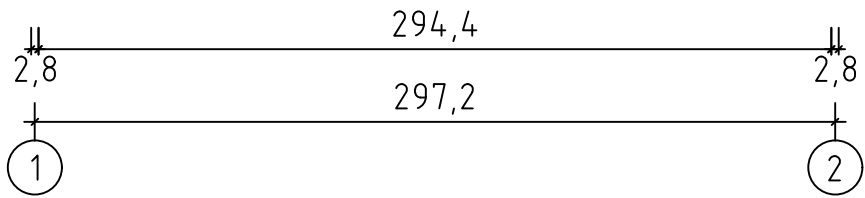
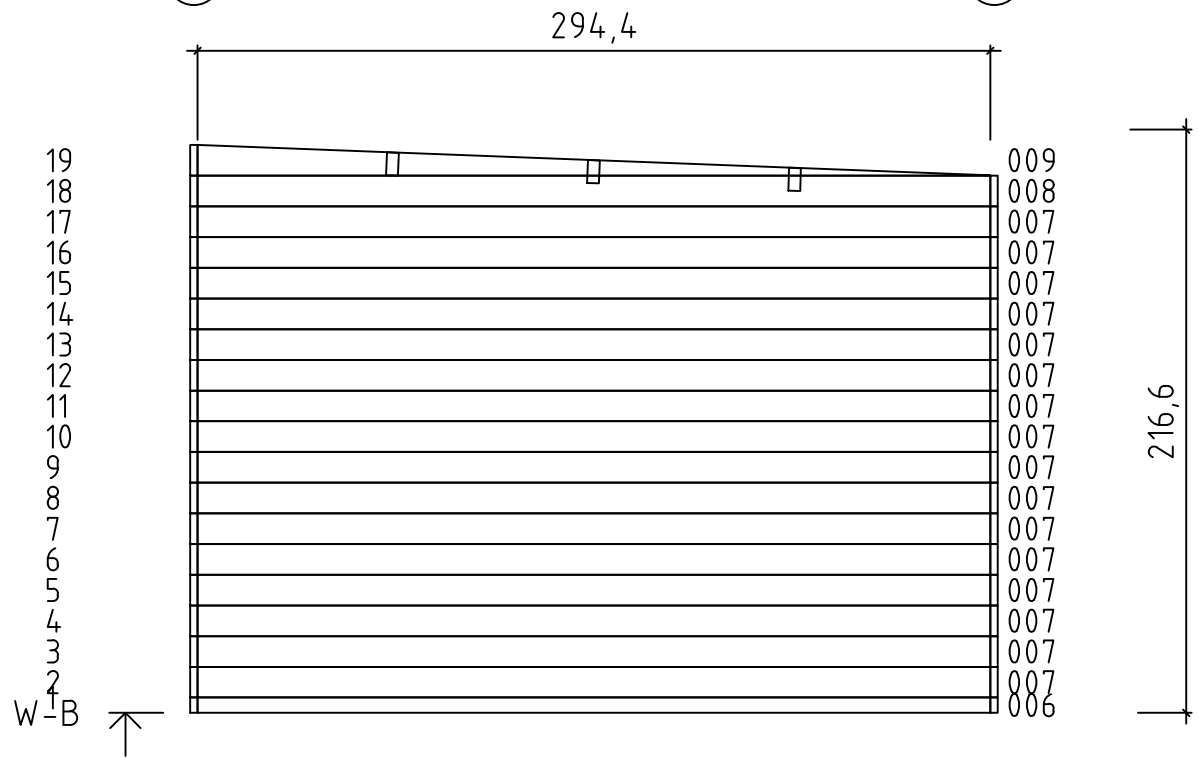
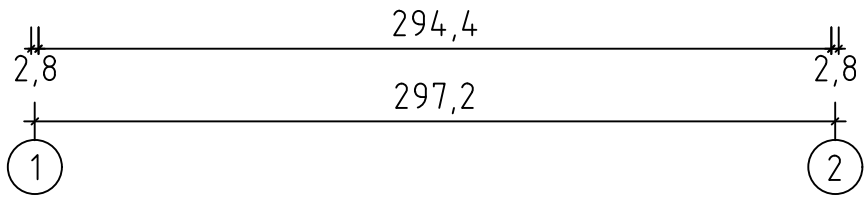
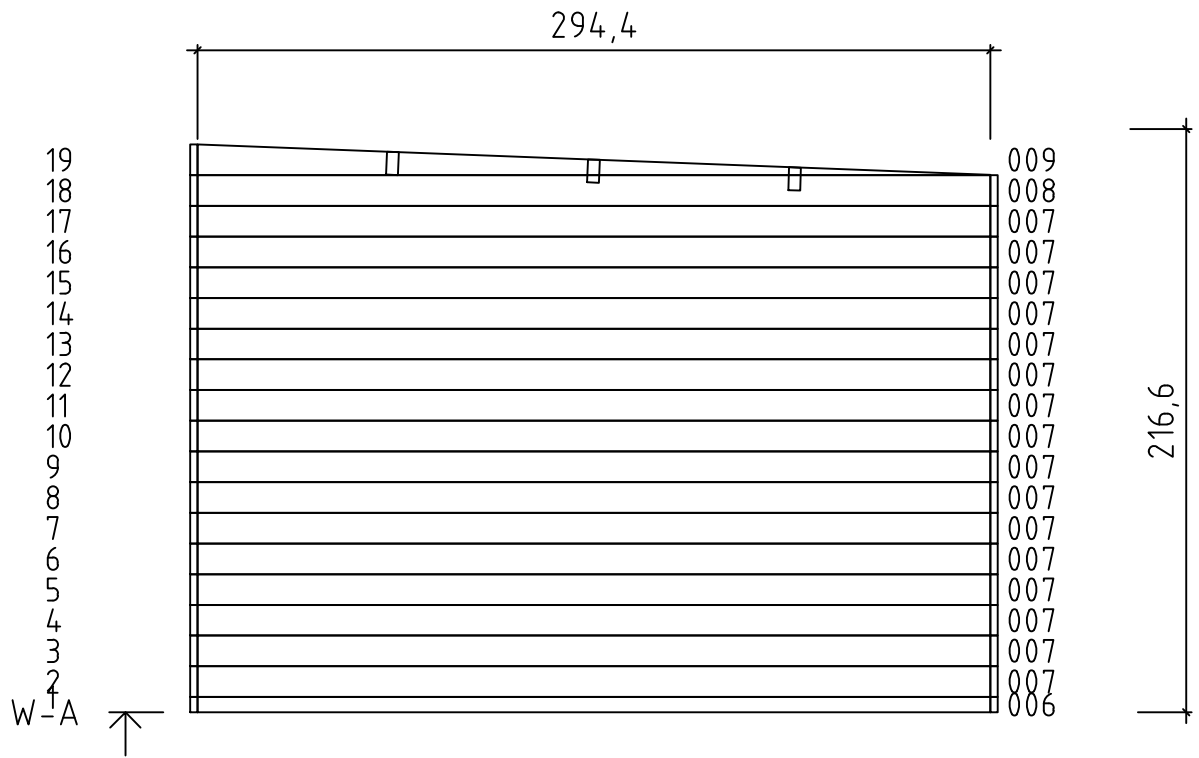







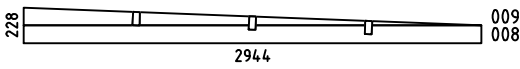
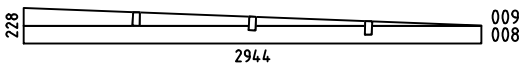
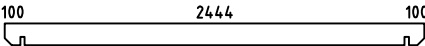
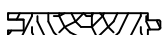



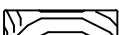
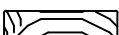

Art. Nr. 2846496

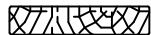
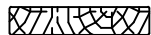

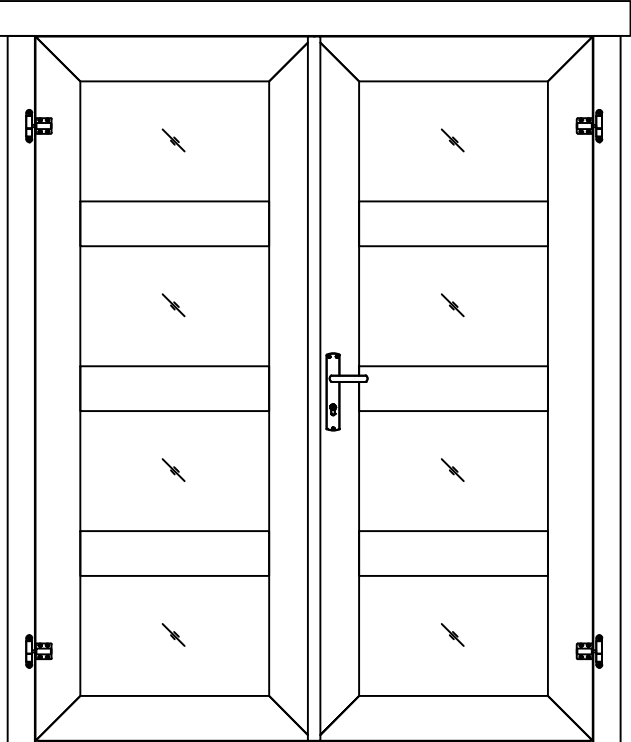
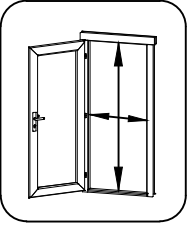
Art. Nr. 2846496



Pos	12.02.2020 Piece list - Stückliste - Liste des pièces - Elementi - Stuklijst - Tükítabel Art. Nr. 2846496	5/6	Q	P (mm)	L (mm)
001			2	28x57	480
002			32	28x114	480
003			17	28x114	2500
004			2	28x114	2700
005			1	28x57	2500
006			2	28x57	2944
007			32	28x114	2944
WA-1			1		
WB-1			1		
A-PR1	Roof beam - Dachbalken - Panne de toit - Perlina del tetto - Gordingen / dakbalk - Pärilin 		3	44x140	2700
DB	Roof boards - Dachbretter - Voliges - Perlina per tetto - Dakhout - Katuselaud 		30	90x15	3250
RFF1	Roofing felt fillet - Dachpappenleiste - Baguette de fixation du feutre bitumeux - Asse per fissaggio guaina bituminosa - Afdekljst asfaltpapier - Katusepapiiist 		1	15x45	2730
RFF2	Roofing felt fillet - Dachpappenleiste - Baguette de fixation du feutre bitumeux - Asse per fissaggio guaina bituminosa - Afdekljst asfaltpapier - Katusepapiiist 		2	15x45	3270
DL1	Corner fillet - Deckleiste - Profils de finition angles a l'exterieur - Massello d'angolo - (hoek)lijst - Nurgaliist 		2	15x70	1995
DL2	Corner fillet - Deckleiste - Profils de finition angles a l'exterieur - Massello d'angolo - (hoek)lijst - Nurgaliist 		2	15x70	2109
DL3	Corner fillet - Deckleiste - Profils de finition angles a l'exterieur - Massello d'angolo - (hoek)lijst - Nurgaliist 		2	15x90	1881
DL4	Corner fillet - Deckleiste - Profils de finition angles a l'exterieur - Massello d'angolo - (hoek)lijst - Nurgaliist 		2	15x90	1995
EP1	Corner stud - Eckpfosten - Poteaux d'angle pour fixation des madriers - Perno angolare - Hoek staander (kolom) - Nurgapost 		2	44x44	1970
EP2	Corner stud - Eckpfosten - Poteaux d'angle pour fixation des madriers - Perno angolare - Hoek staander (kolom) - Nurgapost 		2	44x44	2080
TB	Fascia board - Traufbrett - Bandeau de toit - Finitura lati tetto - Gevellijst - Räästalaud 		1	15x45	2700
TL	Fixing fillet - Fixirungsleiste - Profil de fixation - Massello di fissaggio - Bevestiging lijstwerk - Tenderliist 		2	18x28	1850
GL1	Gable moulding - Giebelleiste - Planche de rive - Finitura per frontale e retro del tetto - Gevellijst - Viilulaud 		1	15x120	2730
GL2	Gable moulding - Giebelleiste - Planche de rive - Finitura per frontale e retro del tetto - Gevellijst - Viilulaud 		2	15x120	3300

Pos	11.02.2020 Piece list - Stückliste - Liste des pièces - Elementi - Stuklijst - Tükítabel 1494x1850 TUK.4.020.MXVP.MMX28 MXGA+28	1/2	Q	P (mm)	L (mm)
<p>Glass size - Glasgröße - Taille de la vitre - Misura del vetro - Glas afmeting - Klaasi mõõt: 502x325 mm</p>   <p>1418x1792 mm</p>					
1	Upper door jamb - Türrahmen oben - Cadre de porte supérieur - Telaio superiore della porta - Bovendorpel - Ukse ülemine leng		1	66x100	1438
2	Left door jamb - Türrahmen links - Cadre de porte gauche - Telaio montante sinistro della porta - Linkerstijl deurframe - Ukse vasak leng		1	66x80	1850
3	Right door jamb - Türrahmen rechts - Cadre de porte droit - Telaio montante destro della porta - Rechterstijl deurframe - Ukse parem leng		1	66x80	1850
4	Doorstep - Swelle - Barre de seuil - Soglia della porta - Deurdorpel - Lävepak		1	20x21	1418
5	Connection strip - Deckleiste - Baguette de battement - Profilo verticale della porta - Stulplijst - kokkuvaltšiliist		1	13x32	1812

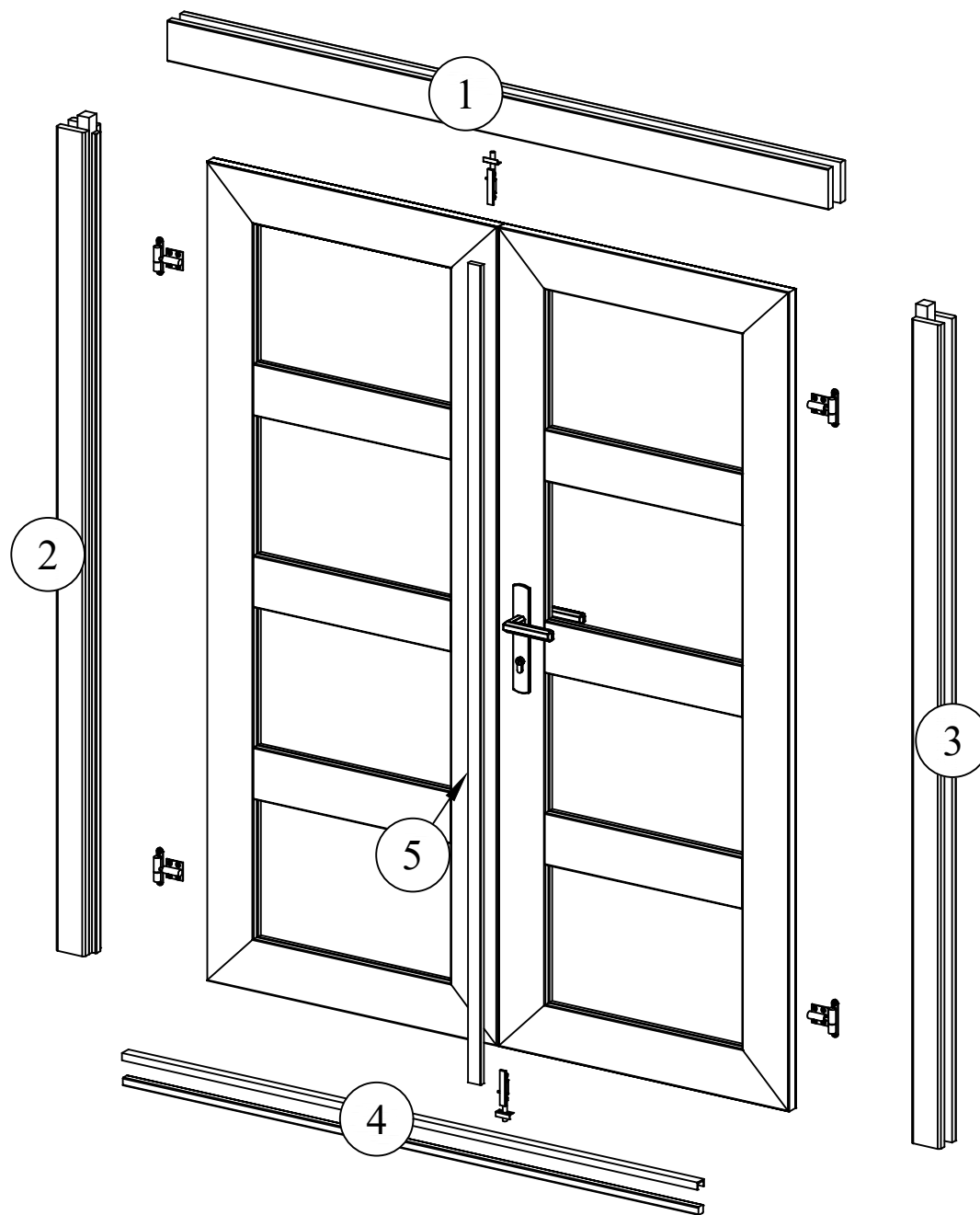

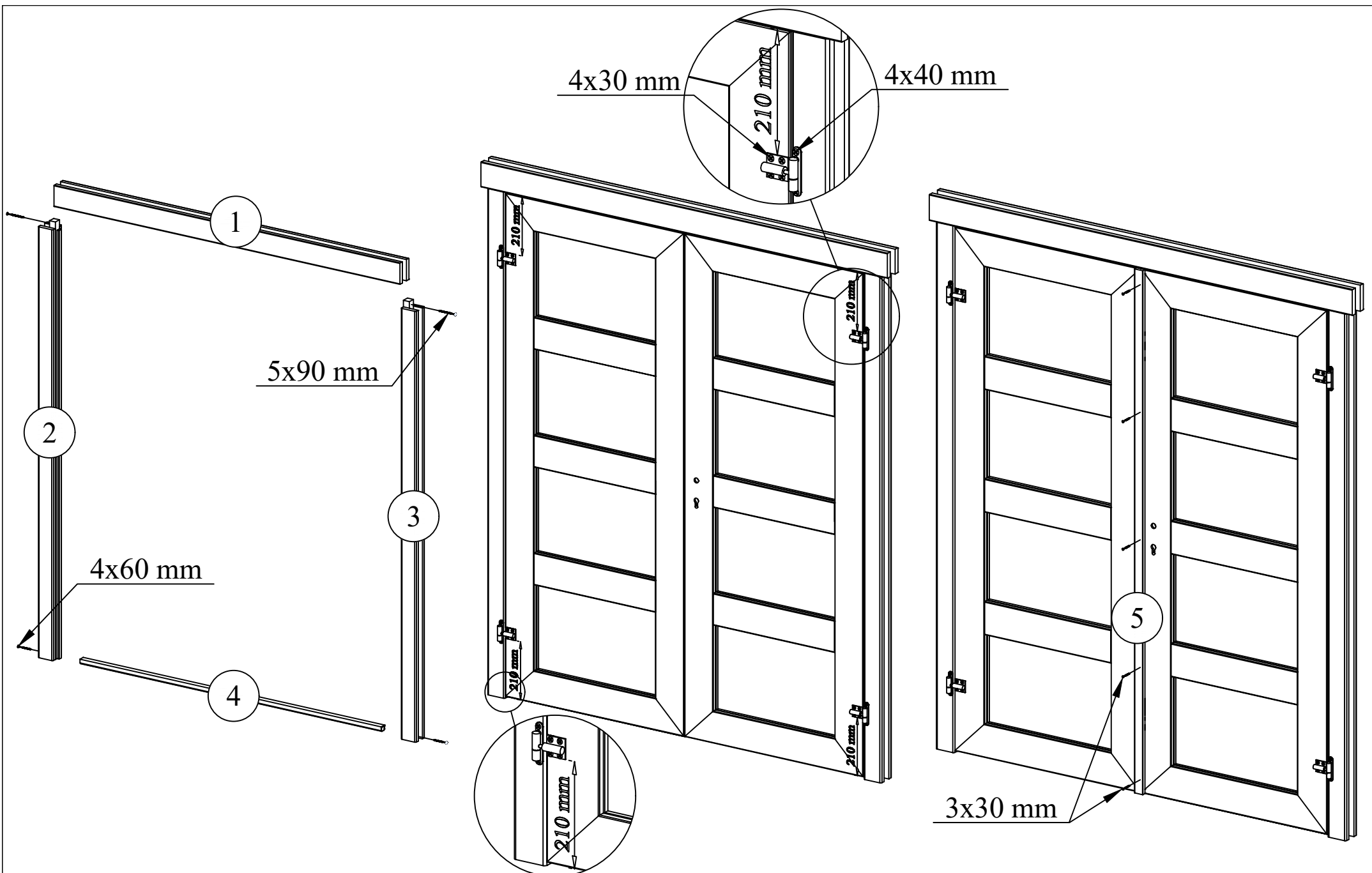

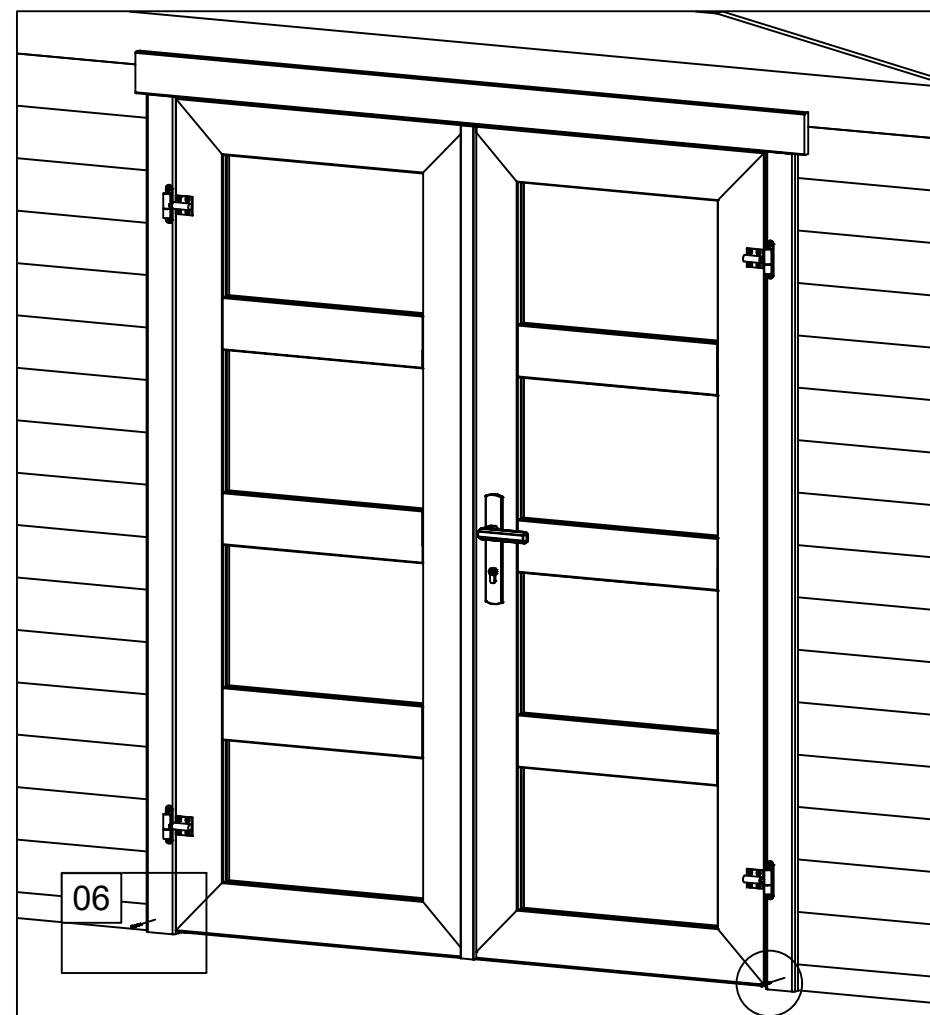
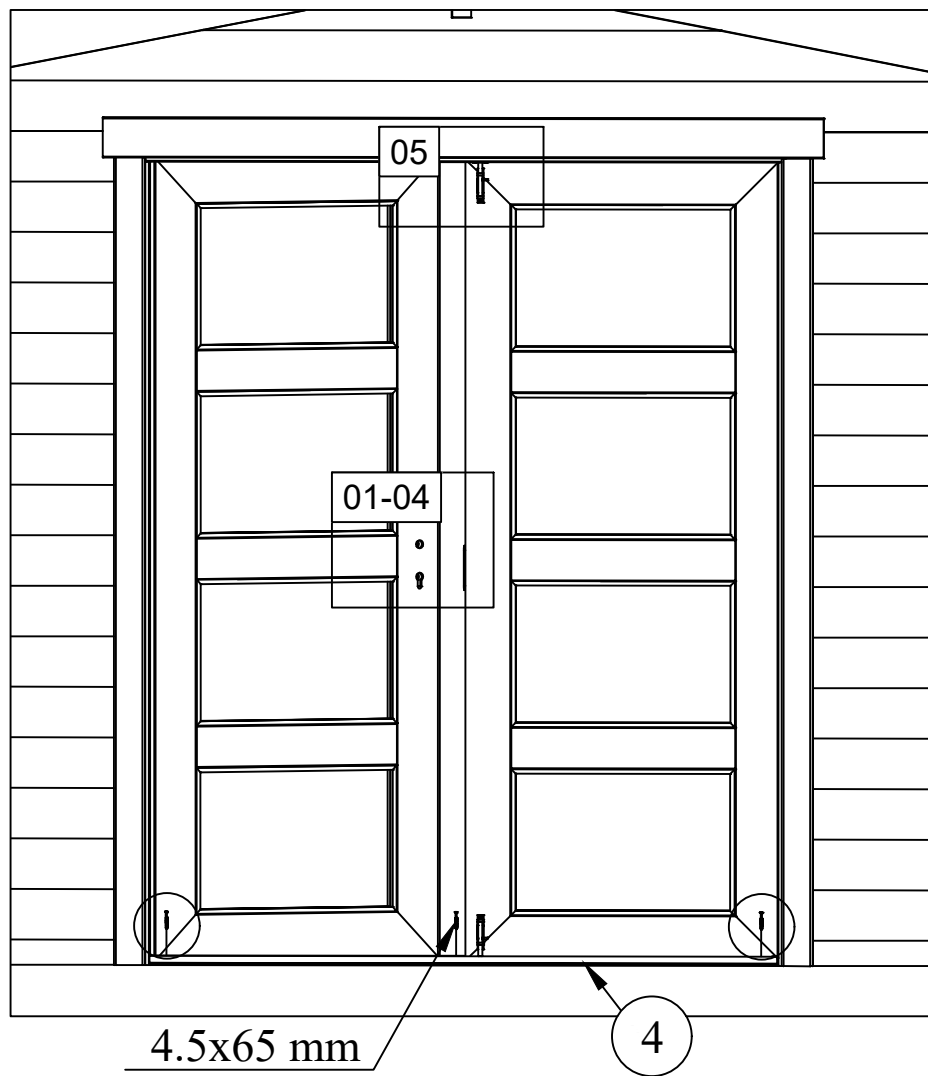

01

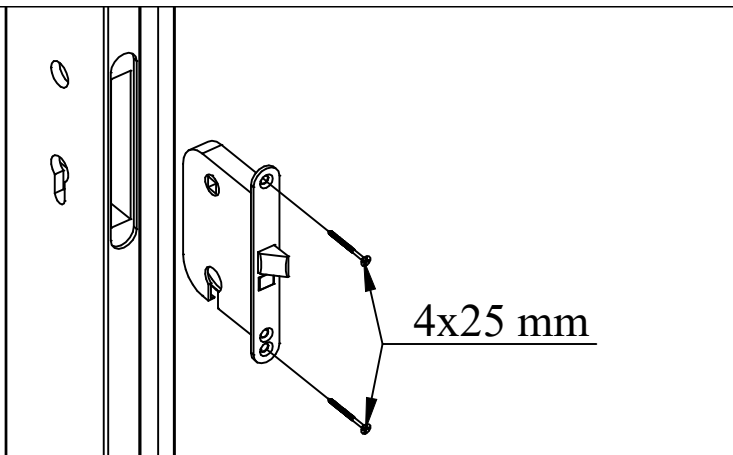

04



02



05



03



06

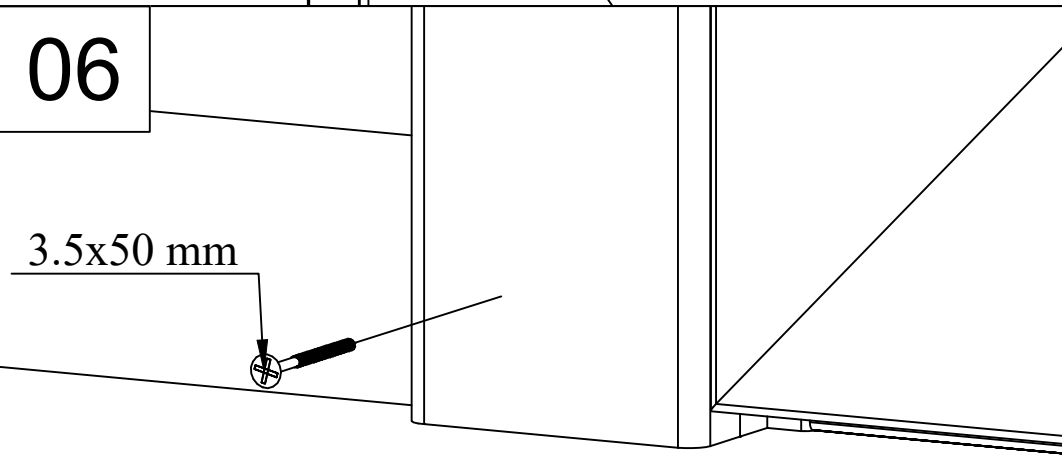

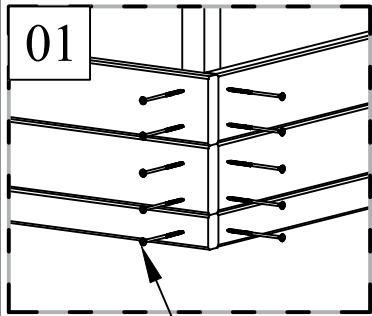

HS13

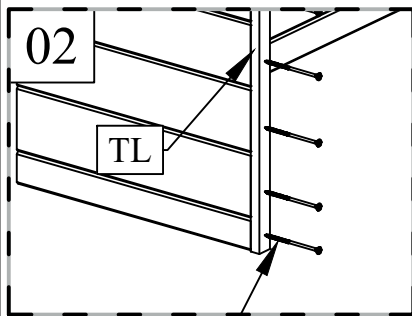
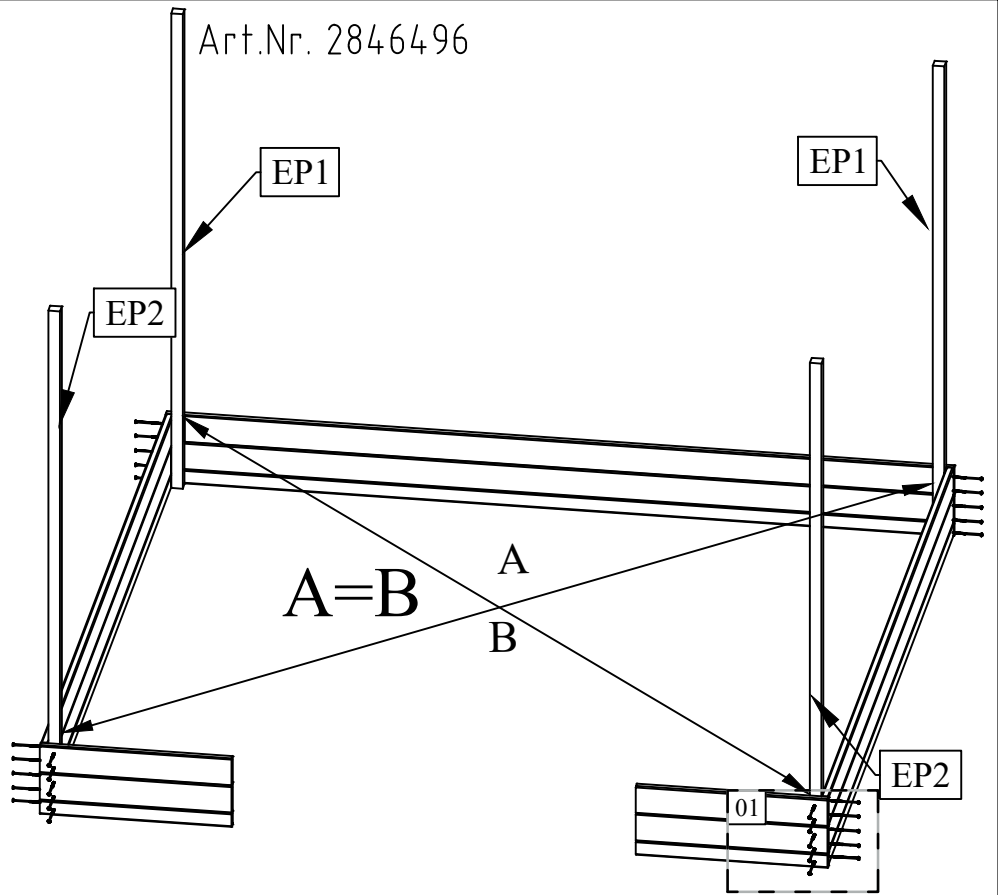

HS12

